



CATALOGO  
PRODOTTI





## INDICE

---

Camini in refrattario.....	pag 3
Gamma Jolly.....	pag 5
Camini in ghisa.....	pag 8
Rivestimenti.....	pag 9
Camini Mattoncini Refrattari su misura.....	pag 11
Forni in refrattario vibrocompreso.....	pag 12
Barbecue da esterno.....	pag 14

# CAMINI IN REFRATTARIO

Caminetto prefabbricato in argilla espansa  
Focolare in refrattario ad alta resistenza  
Possibilità di rendere tutti i modelli semiaperti DX SX togliendo il fianco laterale

## TC/65 - TC/75 - TC/95



CAMINO	Ambiente m <sup>2</sup>	Scarico fumi	Canna fumaria	Preso aria esterna	Kg
TC/65	15	Ø 20	Ø 20 4,00 ÷ 6,50	250 cmq	250
			Ø 25 3,00 ÷ 4,00		
TC/75	20	Ø 25	Ø 25 4,50 ÷ 6,50	300 cmq	300
			Ø 30 3,00 ÷ 4,50		
TC/95	25	Ø 25	Ø 25 oltre 6,50	300 cmq	380
			Ø 30 3,00 ÷ 6,50		

### MISURE TECNICHE (cm)

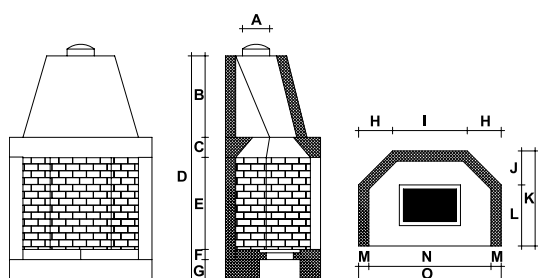

	A	B	C	D	E	F	G	H	I	J	K	L	M	N	O
TC/65	Ø 20	45	10	118	46	6	10	22,5	36	20	50	30	8	65	81
TC/75	Ø 25	46	14	132	56	6	11	23,5	45	22	60	38	8	75	92
TC/95	Ø 25	50	14	140	60	6	10	33	47	26	63	36,5	8	95	111

## TC/114



Ambiente m <sup>2</sup>	Scarico fumi	Canna fumaria	Preso aria esterna	Kg
30	Ø30	Ø30	350 cmq	450

### MISURE TECNICHE (cm)

	A	B	C	D	E	F	G	H	I	J	K	L	M	N	O
Ø 30	50	13	144	56	6	16	20,5	73	26	70	44	7	100	114	

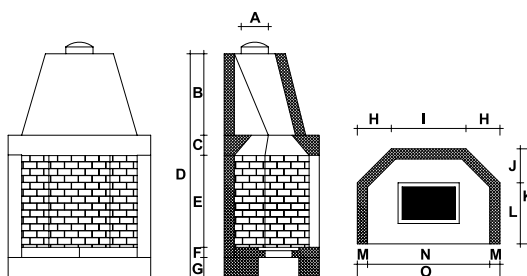

# TC/126X90



Ambiente m <sup>2</sup>	Scarico fumi	Canna fumaria	Preso aria esterna	Kg
35	Ø 30	Ø 30	350 cmq	550

## MISURE TECNICHE (cm)

	A	B	C	D	E	F	G	H	I	J	K	L	M	N	O
Ø	30	50	12	150	62	6	18	28	70	29	90	61	8	110	126

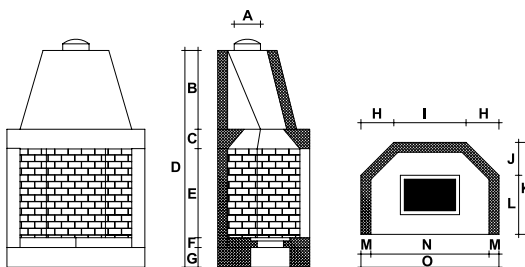

# TC/140X70 RF



Ambiente m <sup>2</sup>	Scarico fumi	Canna fumaria	Preso aria esterna	Kg
35	Ø 30	Ø 30	350 cmq	450

## MISURE TECNICHE (cm)

	A	B	C	D	E	F	G	H	I	J	K	L	M	N	O
Ø	30	50	12	167	82	4	8	24	92	63	70	7	10	120	140

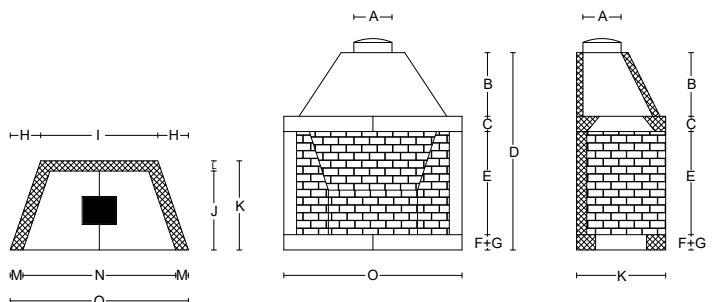

\*Pianofuoco e basamento unico getto

# GAMMA JOLLY

CAMINO	A	B	C	D	E	F	H	I	J	K	L	M	N	O	Kg
JOLLY 81 Ø	20	28	10	97	47	12	/	/	/	/	45	6	65	77	200
JOLLY 101 Ø	25	50	10	127	55	12	13,5	68	7	55	48	9	77	95	230
JOLLY 121 Ø	25	55	10	137	60	12	16,5	83	7	64	57	9	98	116	300

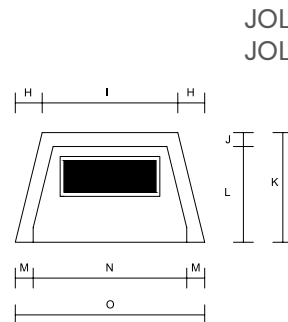
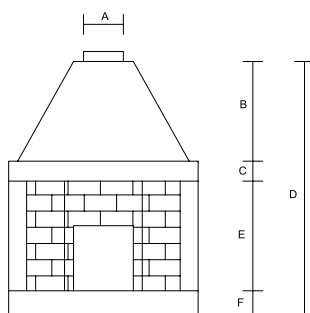

JOLLY 101  
JOLLY 121

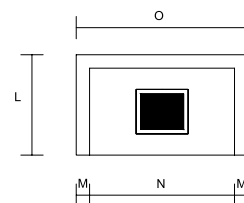

JOLLY 81

\*Pianofuoco e basamento unico getto

# TRIFACCIALE



Possibilità di rendere tutti i modelli a parete e la gamma Jolly (ad esclusione del TC 126x90 e del TC 140x70) aperti su 2 lati.

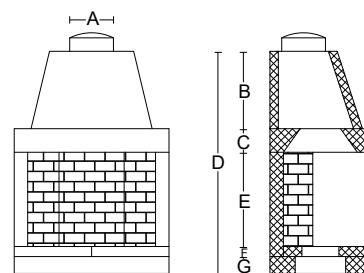
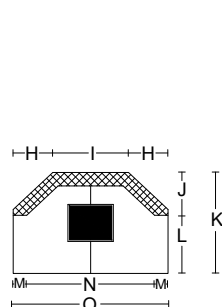
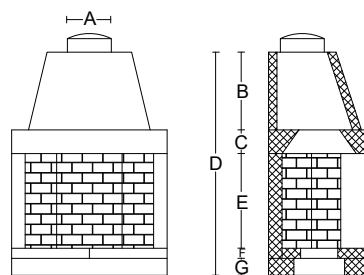
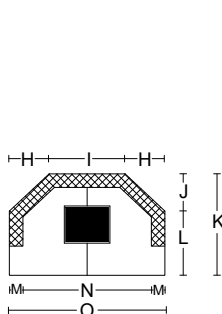

# TC/55X75 • TC/85X60 • TC/95X65 • TC/95X75 • TC/108X68

Caminetto prefabbricato in argilla espansa. Focolare in refrattario ad alta resistenza. Focolare reversibile DX/SX



CAMINO	Ambiente m <sup>2</sup>	Scarico fumi	Canna fumaria	Preso aria esterna	Kg
TC/55x75	20	Ø 25	Ø 20 4,00 ÷ 6,50 Ø 25 3,00 ÷ 4,00	300 cmq	250
TC/85x60	25	Ø 25	Ø 20 oltre 6,50 Ø 25 4,50 ÷ 6,50 Ø 30 3,00 ÷ 4,50	300 cmq	300
TC/95x65	30	Ø 30	Ø 25 oltre 6,50 Ø 30 3,00 ÷ 6,50	350 cmq	390
TC/95x75	30	Ø 30	Ø 25 oltre 6,50 Ø 30 3,00 ÷ 6,50	350 cmq	400
TC/108x68	30	Ø 25	Ø 25 oltre 6,50 Ø 30 3,00 ÷ 6,50	350 cmq	330
*JOLLY 85	20	Ø 20	Ø 20 4,00 ÷ 6,50 Ø 25 3,00 ÷ 4,00	300 cmq	250
*POKER	30	Ø 25	Ø 25 oltre 6,50 Ø 30 3,00 ÷ 6,50	350 cmq	250

\*Pianofuoco e basamento unico getto

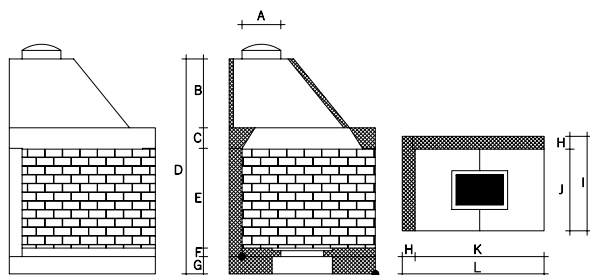

## MISURE TECNICHE (cm)

	A	B	C	D	E	F	G	H	I	J	K	L
<b>TC/55x75</b>	Ø 25	45	12	133	56	6	13	8	55	47	67	75
<b>TC/85x60</b>	Ø 25	46	12	133	56	6	13	8	60	52	77	85
<b>TC/95x75</b>	Ø 30	60	12	146	56	6	12	8	75	67	87	95
<b>TC/95x75</b>	Ø 30	60	12	146	56	6	12	8	75	67	87	95
<b>TC/108x68</b>	Ø 25	40	8	115	55	4	8	10	68	58	98	108
<b>JOLLY 85</b>	Ø 20	40	7	114	55	4	8	9	55	46	61	70
<b>POKER</b>	Ø 25	40	10	117	55	4	8	9	58	49	86	95

## POSSIBILITÀ DI RENDERE TUTTI I MODELLI CHIUSI O SEMIAPERTI



SEMIAPERTO

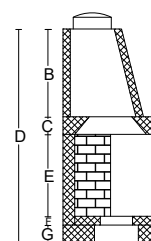
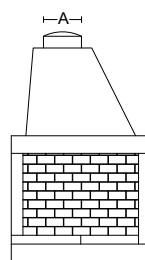
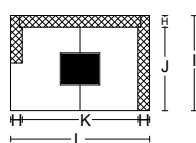

CHIUSO SU 2 LATI

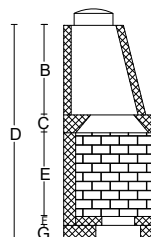
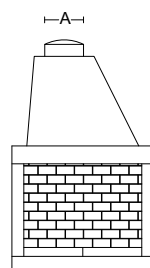
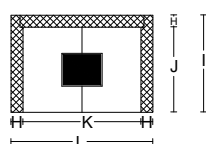

# TC/85 ESA

Modello ad angolo, realizzato nella parte esterna in conglomerato cementizio alleggerito, vano a fuoco in refrattario. Canna fumaria cm Ø 20 altezza min. mt 3



\*Pianofuoco e basamento unico getto

	A	B	C	D	E	F	G	H	I	J	K	L
Ø	20	42	8	122	60	4	8	9,5	85	17	85	119

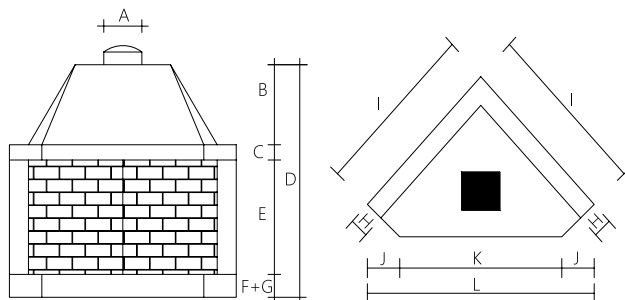

Peso Kg 350

# TC 80/ESA

Modello ad angolo, realizzato nella parte esterna in conglomerato cementizio alleggerito, vano a fuoco in refrattario.



## MISURE TECNICHE (cm)

	A	B	C	D	E	F	G	H	I	J	K	L	M
Ø	25	40	13	126	52	6	15	8	72	85	80	40	56

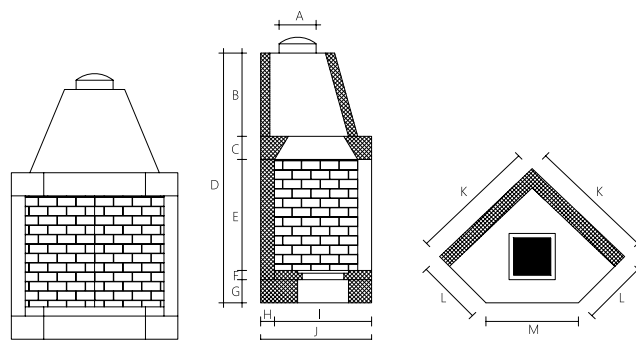

Peso Kg 350

# CAMINI IN GHISA

## TC 115 GH



### CARATTERISTICHE

Struttura: in argilla espansa  
 Focolare: in ghisa  
 Piano fuoco: in ghisa  
 Registro fumi: regolabile internamente  
 Cassetto cenere: estraibile dal focolare  
 Combustibile: legna  
 Riscaldamento: a convenziona naturale e irraggiamento

### DATI TECNICI E DIMENSIONI

Scarico fumi: Ø 30 cm  
 Diametro canna fumaria a 4,5 mt: Ø 35 cm  
 Diametro canna fumaria oltre a 4,5 mt: Ø 30 cm  
 Presa aria esterna (sezione utile minima): 350 cm<sup>2</sup>  
 Peso: 385 kg

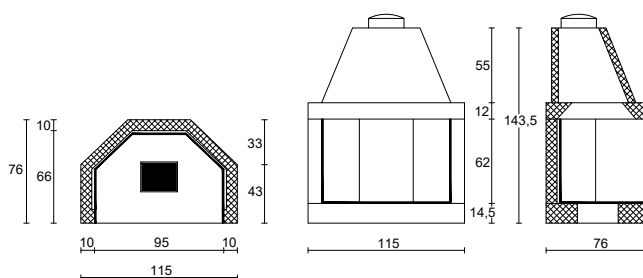

## MODULAR

Modello realizzato nella parte esterna in conglomerato cementizio alleggerito, piano fuoco in refrattario di elevato spessore. Possibilità di essere semiaperto, angolare oppure chiuso su entrambi i lati



### MISURE TECNICHE (cm)

	A	B	C	D	E	F	H	J	K	L	M	N	O
Ø	25	50	12	132	55	15	10	24	58	24	10	75	95

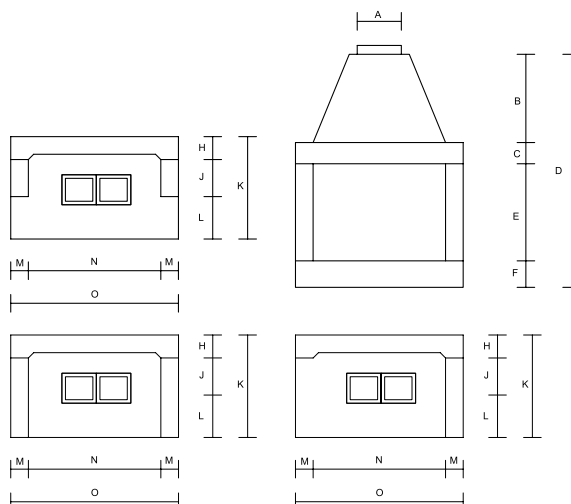



# RIVESTIMENTI

Rivestimenti realizzati per ogni esigenza e tipo di spazio, con qualsiasi materiale

## RIVESTIMENTO PARETE MODELLO LIPARI

Modello a parete con possibilità di sistemazione ad angolo 45°, realizzato nella parte esterna in conglomerato cementizio agglomerato, vano fuoco in refrattario



CAMINO	A	B	C	D	E	F	G	H	I
TC 75	92	25	25	88	142	10	70	36	6
TC 95	111	25	25	91	161	10	74	36	6
TC 114	114	25	25	98	164	10	69	36	6

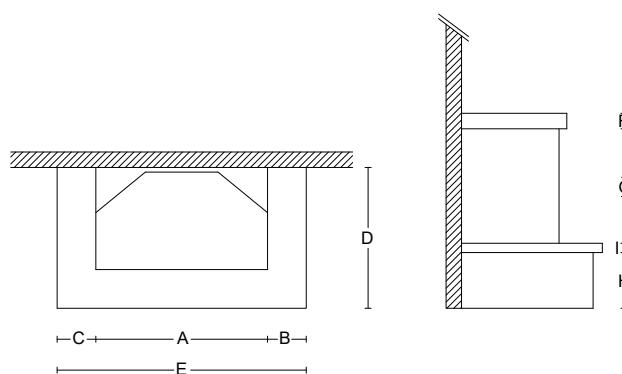

## RIVESTIMENTO PARETE MODELLO ISTRIA

Modello a parete con possibilità di sistemazione ad angolo 45°, realizzato nella parte esterna in conglomerato cementizio agglomerato, vano fuoco in refrattario



CAMINO	A	B	C	D	E	F	G	H	I
TC 75	92	25	25	88	142	10	70	36	6
TC 95	111	25	25	91	161	10	74	36	6
TC 114	114	25	25	98	164	10	69	36	6

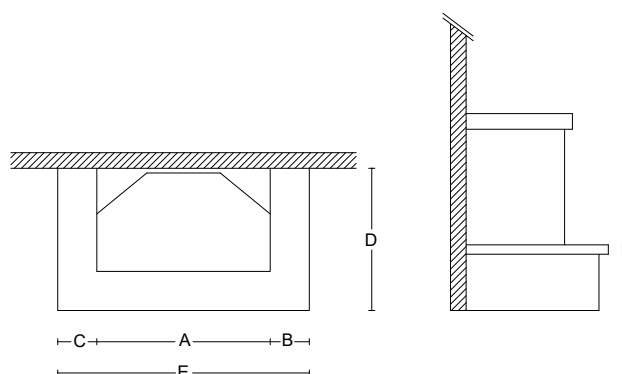

# RIVESTIMENTO ANGOLARE MODELLO ADIGE



CAMINO	A	B	C	D	E	F	G	H	I
TC 75x55	75	25	83	103	68	34	10	12	6
TC 85x60	85	25	88	113	68	34	10	12	6
TC 95x65	95	25	93	123	63	34	10	12	6
TC 95x75	95	25	103	123	63	34	10	12	6
TC 108x68	108	25	96	136	63	34	10	13	6

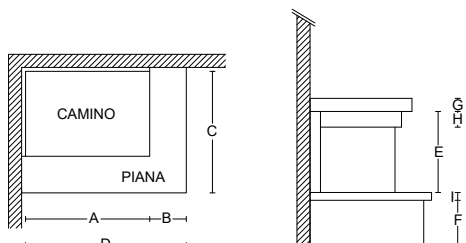

# RIVESTIMENTO ANGOLARE MODELLO CIPRO



CAMINO	A	B	C	D	E	F	G	H	I	K	M
TC 75x55	75	25	83	103	68	34	10	12	6	79	49
TC 85x60	85	25	88	113	68	34	10	12	6	79	49
TC 95x65	95	25	93	123	63	34	10	12	6	79	49
TC 95x75	95	25	103	123	63	34	10	12	6	79	49
TC 108x68	108	25	96	136	63	34	10	13	6	79	49

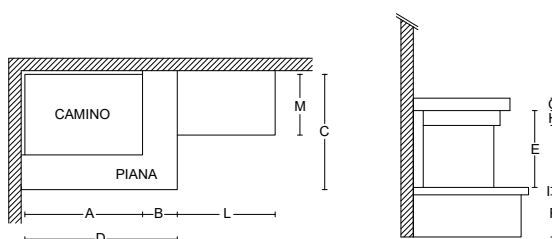

# RIVESTIMENTO ANGOLARE MODELLO BALEARI



CAMINO	A	B	C	D	E	F	G	H	I	K	M
TC 75x55	75	25	83	103	68	34	10	12	6	79	49
TC 85x60	85	25	88	113	68	34	10	12	6	79	49
TC 95x65	95	25	93	123	63	34	10	12	6	79	49
TC 95x75	95	25	103	123	63	34	10	12	6	79	49
TC 108x68	108	25	96	136	63	34	10	13	6	79	49

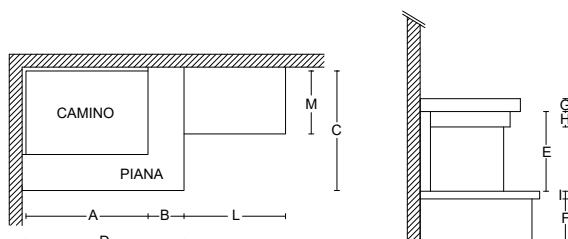

# RIVESTIMENTO MODELLO RODI



CAMINO	A	B	C	D	E	F	G	H	I	L
TC 75	92	60	25	40	88	80	217	25	15	40

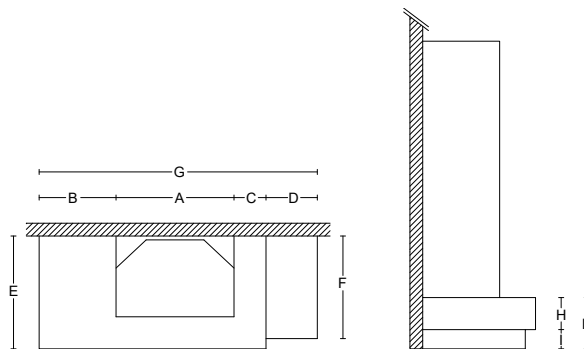

## CAMINI MATTONCINI REFRAATTARI SU MISURA



Caminetti in mattoni refrattari ad alta resistenza termica.  
Ideali per la cottura diretta degli alimenti (tra cui la crescita della nonna)

I caminetti possono essere realizzati su misura a richiesta del cliente.

# FORNI IN REFRATTARIO VIBROCOMPRESSO

Questo forno è stato realizzato per un uso prevalente in ambiente interno. La massa refrattaria è già essa sufficiente per una lunga conservazione del calore. Si raccomanda una temperatura moderata per le prime due o tre accensioni di prova.

## RF 60 Q

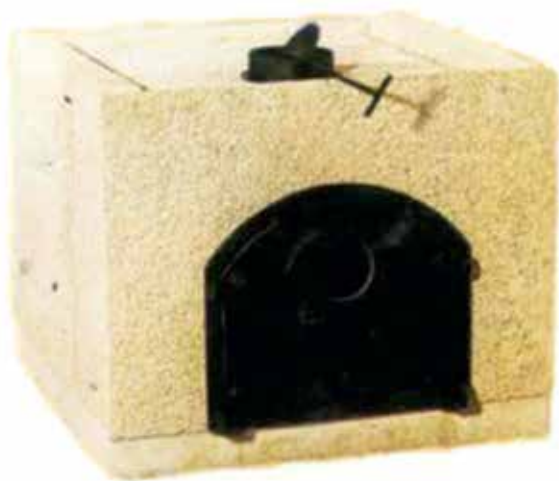

Peso	Altezza e selezione della canna fumaria	
Kg 420	m. 3 min	cm 15x15

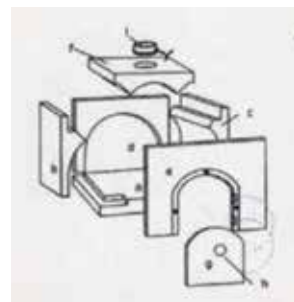
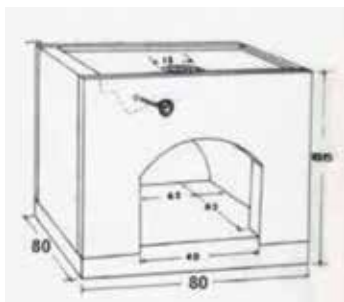

## RF 80

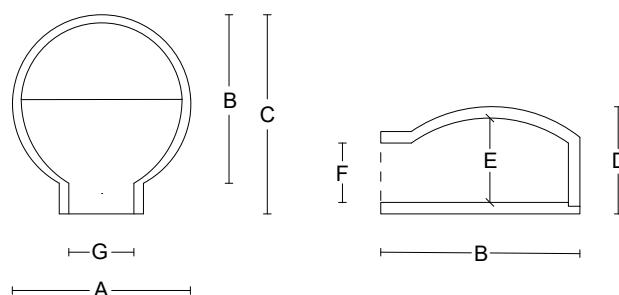

MISURE cm

A	B	C	D	E	F	G
93	104	88	60	44	31	34

Peso Kg 350

# RF 100 | RF 100X130 | RF 130X130

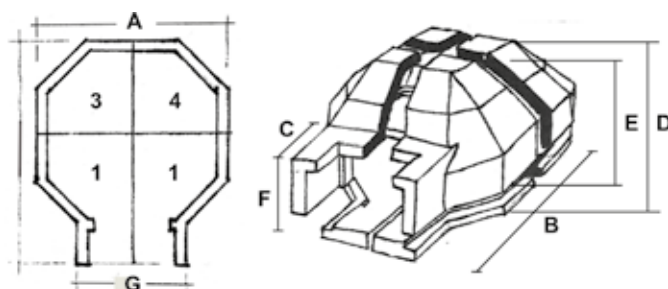

RF 100 - MISURE in cm

A	B	C	D	E	F	G	
112	130	25	55	43	33	52	Peso Kg 400

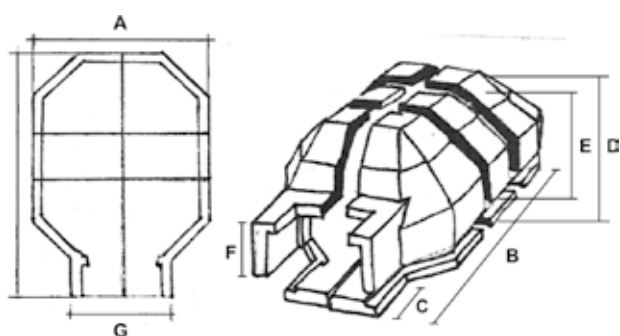

RF 100/130 - MISURE in cm con prolunga da 30

A	B	C	D	E	F	G	
112	160	25	55	43	33	52	Peso Kg 500



RF 130 - MISURE in cm con prolunga da 30

A	B	C	D	E	F	G	
142	160	25	55	43	30	49	Peso Kg 550

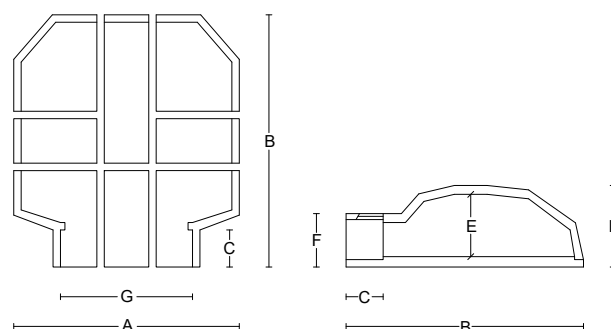

# BARBECUE DA ESTERNO

## MOD. ISCHIA

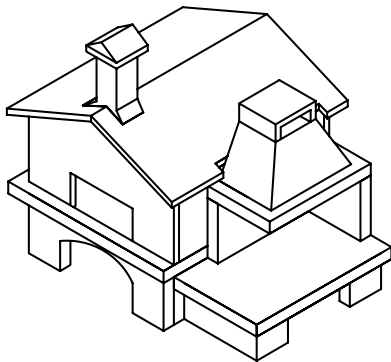

Struttura esterna in cemento armato con piano forno in mattone refrattario ad alta resistenza. Realizzabile con forno RF 80 - RF 100 con o senza barbecue

ALZATA BARBECUE

PIANA BARBECUE

PARTE SUPERIORE BARBECUE

ARCHITRAVE

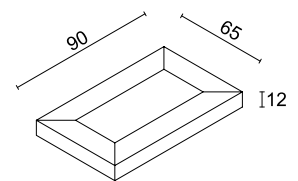
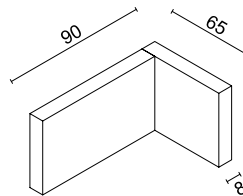
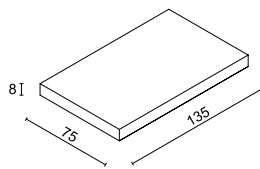
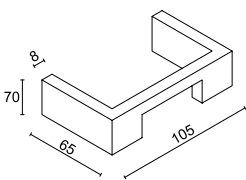

PARTE SUPERIORE FORNO

TETTO

ALZATA FORNO

PIANA FORNO

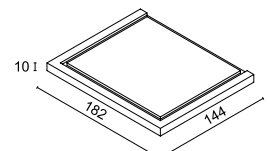
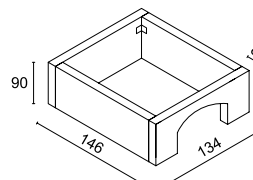
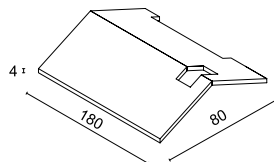
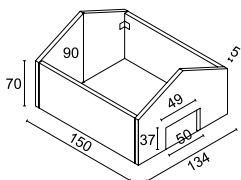

# TAORMINA

Barbecue in refrattario ad alta resistenza con piana in cemento armato levigato



Peso Kg 620

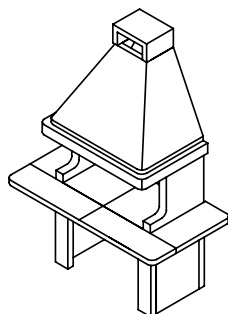

Base a U argilla	107 cm
Piano refrattario	l. 162 x p. 92 x h. 8 cm
Altezza luce bocca	56 cm
Profondità interna bocca	55 cm
Larghezza interna bocca	90 cm
Architrave	8 cm
Cappa	h 55 cm
Comignolo	h 37 cm
Altezza totale	228 cm

# AGRIGENTO

Barbecue in refrattario ad alta resistenza con piana in cemento armato levigato



Peso Kg 520

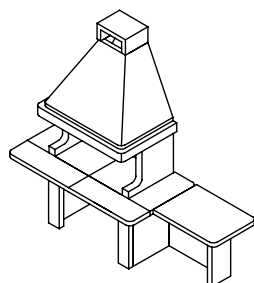

Base a U argilla	78 cm
Piano refrattario	l. 192 x p. 83 x h. 8 cm
Altezza luce bocca	56 cm
Profondità interna bocca	55 cm
Larghezza interna bocca	60 cm
Architrave	8 cm
Cappa	h 55 cm
Comignolo	h 37 cm
Altezza totale	228 cm

# GRILL

Grill senza cappa in refrattario ad alta resistenza



Peso Kg 300

Piano grill	106x83 cm
Spessore piano	8 cm
Altezza basamento	65 cm
Larghezza basamento	78 cm
Larghezza grill	107 cm
Altezza grill	60 cm
Interno utile	64x53 cm



Via A.Volta, 1- Osteria del Gatto  
06022 Fossato di Vico (PG)

Tel. 075 919431

[www.cbcaminettibellucci.it](http://www.cbcaminettibellucci.it)  
[info@cbcaminettibellucci.it](mailto:info@cbcaminettibellucci.it)